COBRA-HEAD LED STREET LIGHT

HT-ST400-30W



1. The applications of the occasions

Street, Garden ,Squares ,School ,Park ,Yards ,pavements...

2. Features

- 1 Use heat sinker inside the lamp for heat dissipation.
- 2 Grey ,White, Dark grey color optional
- 3 IP65.

3. Dimension of the product.

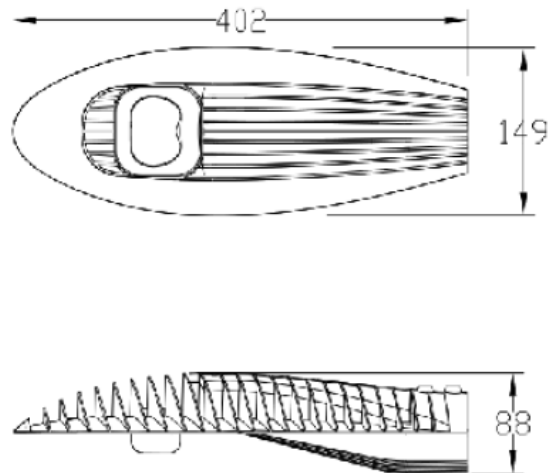

4. Main technical parameters

Item number	HT-ST400-30W
Color of temperature	2700K~6500K optional
Color Rendering Index	>70
Luminous Flux	3000 lm \pm 200 lm
LED luminous efficiency	100-110lm/w
Input wattage	AC100-277V Or DC12/24V
LED Power	30W
System Consumption	30W \pm 3W
Storage Temperature	-40°C~50°C
Working Temperature	-30°C~+60°C;10%-90%RH
LED	Bridgelux(COB)
G.W/N.W.	13.00kg/ 12.00kg
Master box(6 pc)	460*390*390mm
Certificate Compliance	CE,ROHS

5. Light parameter

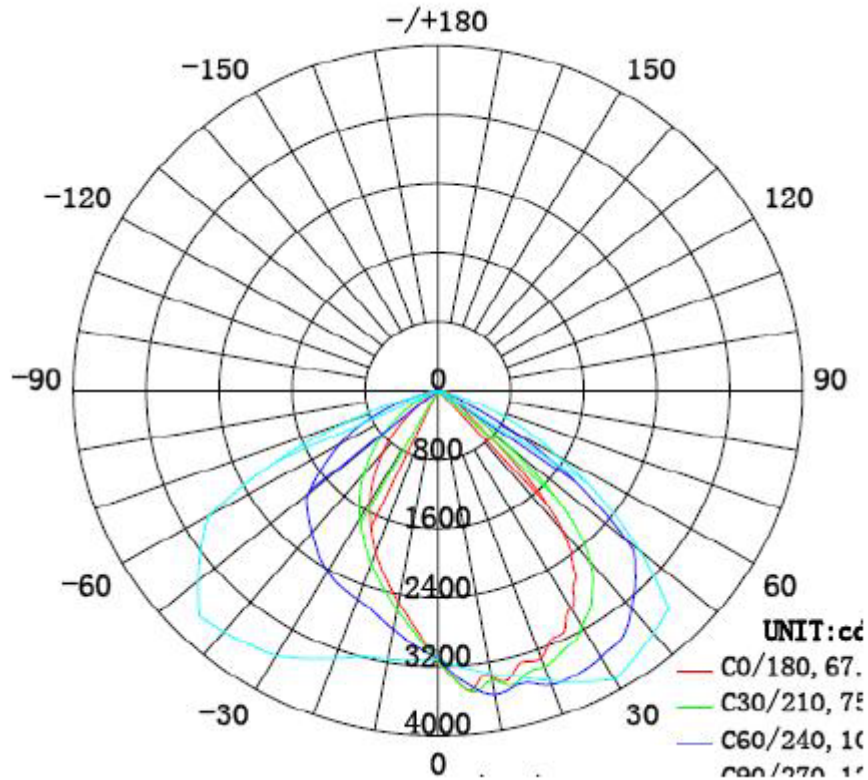

6. Installation

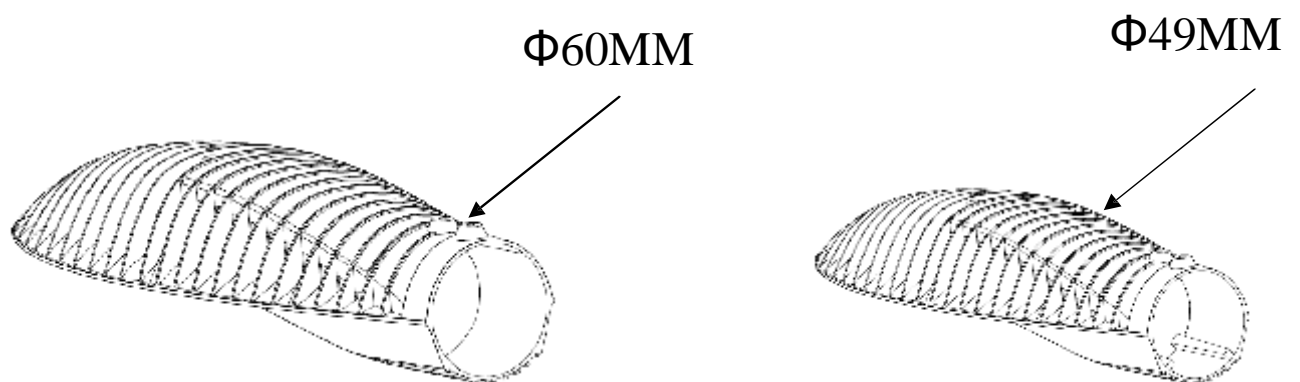

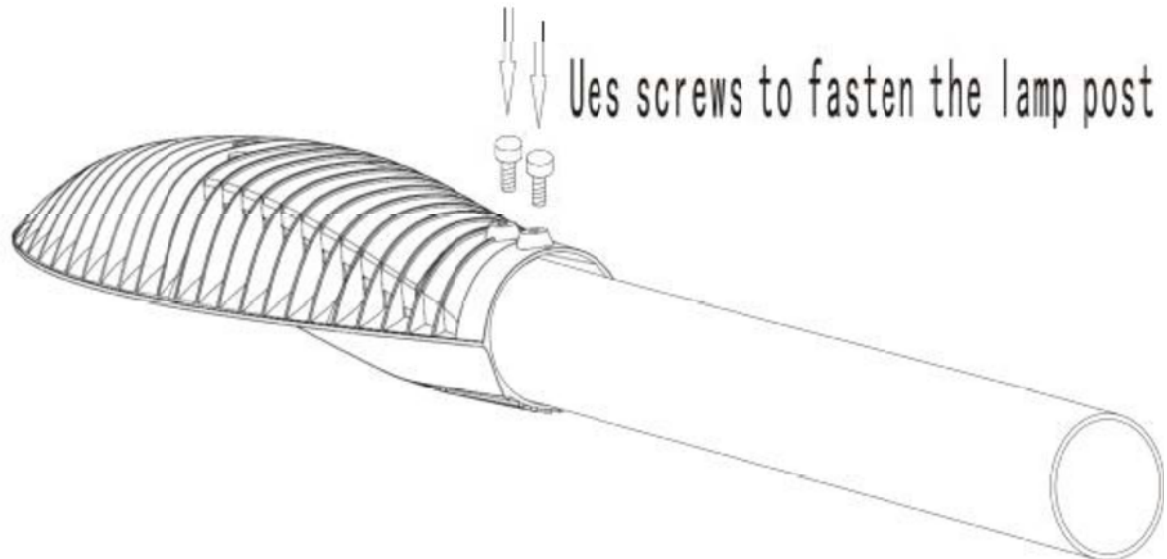

7. Attention for installation.

- Cut off the AC input power before installing on the lamp post.
- Make sure install the lamp correctly to avoid lamp dropping from the lamp post.
- Remove all kinds of covers before turn on the lamp .
- Make sure the lamp connect a ground wire, and test before using.
- Any problem due to disassembling, modifying, or installation not correctly would be out of the warranty.